

Thinking of you
Electrolux



EWW 167443 W

EN WASHER DRYER

USER MANUAL



Electrolux. Thinking of you.

Share more of our thinking at www.electrolux.com

CONTENTS

Safety information	2	Washing programmes	17
Product description	4	Drying Programmes	19
Control panel	5	Care and cleaning	20
First use	8	What to do if...	23
Personalisation	8	Technical data	26
Daily use	9	Consumption values	26
Use - Drying	12	Installation	26
Use - Washing & Drying	13	Electrical connection	29
Helpful hints and tips	14	Environment concerns	29
Drying Hints	16		

Subject to change without notice.



SAFETY INFORMATION

Important! Read carefully & keep for future reference.

- The safety of Your appliance complies with the industry standards and with legal requirements on the safety of appliances. However, as manufacturers, we feel it is our duty to provide the following safety notes.
- It is most important that this instruction book should be retained with the appliance for future reference. Should the appliance be sold or transferred to another owner, or should you move house and leave the appliance, always ensure that the book is supplied with the appliance in order that the new owner can get to know the functioning of the appliance and the relevant warnings.
- You MUST read them carefully before installing or using the appliance.
- Before first starting up, check the appliance for any damage incurred during transport. Never connect up a damaged appliance. If parts are damaged, contact your supplier.
- If the appliance is delivered in the winter months when there are minus temperatures. Store it at room temperature for 24 hours before using for the first time.

GENERAL SAFETY

- It is dangerous to alter the specifications or attempt to modify this product in any way.
- During high temperature wash programmes the door glass may get hot. Do not touch it!
- Make sure that small pets and children do not climb into the drum. To avoid this, please check into the drum before using.
- Any objects such as coins, safety pins, nails, screws, stones or any other hard, sharp material can cause extensive damage and must not be placed into the machine.
- Only use the advised quantities of fabric softener and detergent. Damage to the fabric can ensue if you over-fill. Refer to the manufacturer's recommendations of quantities.
- Wash small items such as socks, laces, washable belts etc in a washing bag or pillow case as it is possible for such items to slip down between the tub and the inner drum.
- Do not use your washing machine to wash articles with whalebones, material without hems or torn material.
- Always unplug the appliance and turn off the water supply after use, cleaning and maintenance.
- Under no circumstances should you attempt to repair the machine yourself. Repairs carried out by inexperienced people

may cause injury or serious malfunctioning. Contact your local Service Centre. Always insist on genuine spare parts.

INSTALLATION

- This appliance is heavy. Care should be taken when moving it.
- When unpacking the appliance, check that it is not damaged. If in doubt, do not use it and contact the Service Centre.
- All packing and transit bolts must be removed before use. Serious damage can occur to the product and to property if this is not adhered to. See relevant section in the user manual.
- After having installed the appliance, check that it is not standing on the inlet and drain hose and the worktop is not pressing the electrical supply cable against the wall.
- If the machine is situated on a carpeted floor, please adjust the feet in order to allow air to circulate freely under the appliance.
- Always be sure, that there is no water leakage from hoses and their connections after the installation.
- If the appliance is installed in a location subject to frost, please read the “dangers of freezing” chapter.
- Any plumbing work required to install this appliance should be carried out by a qualified plumber or competent person.
- Any electrical work required to install this appliance should be carried out by a qualified electrician or competent person.

USE

- This appliance is designed for domestic use. It must not be used for purposes other than those for which it was designed.
- Only wash and dry fabrics which are designed to be machine washed or dried. Follow the instructions on each garment label
- Do not overload the appliance. See the Washing Programme Table.
- Before washing, ensure that all pockets are empty and buttons and zips are fastened. Avoid washing frayed or torn articles and treat stains such as paint, ink, rust, and grass before washing. Under-

wired bras must NOT be machine washed.

- Garments which have been in contact with volatile petroleum products should not be machine washed. If volatile cleaning fluids are used, care should be taken to ensure that the fluid is removed from the garment before placing in the machine.
- As some duvets and eiderdowns should be washed/dried in large commercial machines because of their bulk, please check with the manufacturer of the item before washing in a domestic machine.
- The users should always check that they have not left their gas lighters (disposable or otherwise) in their clothing.
- Never tumble dry items that have had contact with chemicals such as dry cleaning fluid. These are of a volatile nature and could cause an explosion. Only tumble dry items which have been washed in water or require airing.
- Plastic detergent dispensers should not remain in the drum during the drying cycle, as the plastic used is not designed to withstand the heat. If you wish to wash-through-to-dry you should use the conventional detergent dispenser drawer.
- Never pull the power supply cable to remove the plug from the socket; always take hold of the plug itself.
- Never use your new appliance if the power supply cable, the control panel, the working surface or the base are damaged so that the inside of the appliance is accessible.

CHILD SAFETY

- This appliance is not intended for use by person (including children) with reduced physical sensory or mental capabilities or lack of experience and knowledge unless they have been given supervision or instruction concerning use of the appliance by a person responsible for their safety.
- Children should be supervised to ensure that they do not play with the appliance.
- The packaging components (e.g. plastic film, polystyrene) can be dangerous to children - danger of suffocation! Keep them out of children's reach.

- Keep all detergents in a safe place out of children's reach.
- Make sure that children or pets do not climb into the drum. To prevent children and pets becoming trapped inside the drum the machine incorporates a special feature. To activate this device, rotate the button (without pressing it) inside the door clockwise until the groove is horizontal. If necessary use a coin.

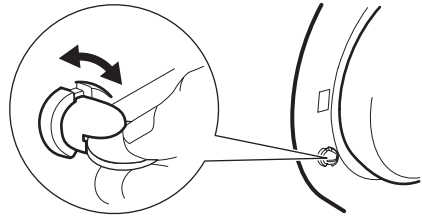

To disable this device and restore the possibility of closing the door, rotate the button counterclockwise until the groove is vertical.

PRODUCT DESCRIPTION

- i** Your new appliance meets all modern requirements for effective treatment of laundry with low water, energy and detergent consumption. Its new washing system allows total use of detergent and reduces water consumption so saving energy.

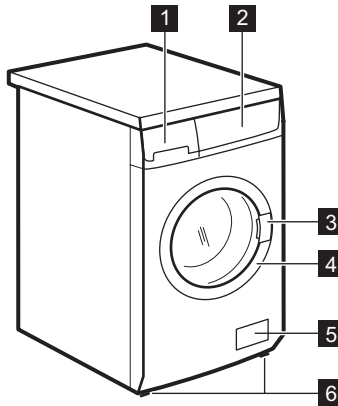



- 1** Detergent dispenser drawer
- 2** Control panel
- 3** Door opening handle

- 4** Rating Plate
- 5** Drain pump
- 6** Adjustable feet

DETERGENT DISPENSER DRAWER

 Compartment for detergent used for prewash and soak phase or for stain remover used during the stain action phase (if available). The prewash and soak detergent is added at the beginning of the wash programme. The stain remover is added during the stain action phase.

 Compartment for powder or liquid detergent used for main wash. If using liquid detergent pour it **just before** starting the programme.

 Compartment for liquid additives (fabric softener, starch).

Follow the product manufacturer's recommendations on quantities to use and do not exceed the «**MAX**» mark in the detergent dispenser drawer. Any fabric softener or starching additives must be poured into the compartment before starting the wash programme.

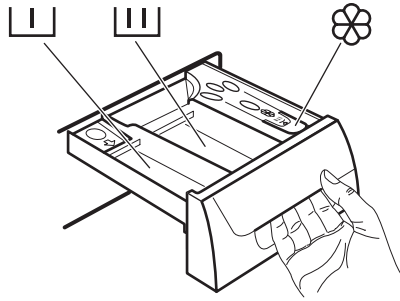

CONTROL PANEL

 Below is a picture of the control panel. It shows the programme selector dial as well as the buttons, pilot light and the display. These are presented by relevant numbers on the following pages.

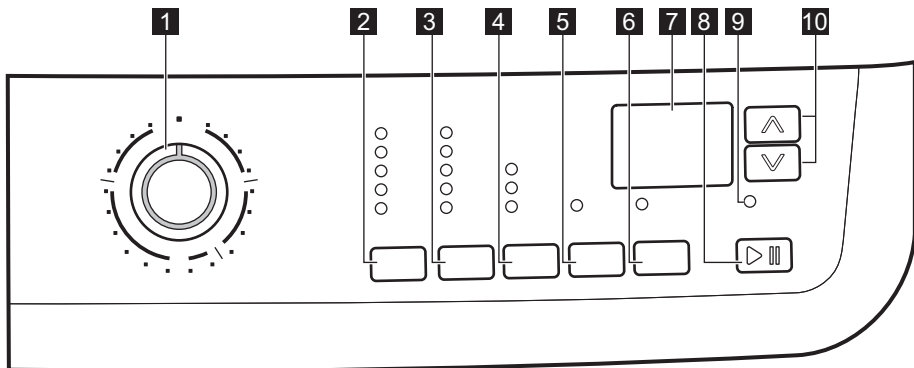

1 Programme selector dial

2 TEMPERATURE button (**Temp.**)

3 SPIN REDUCTION button (**Centrifug.**)

4 AUTODRY button (**Droogtegraad**)

5 DRYING TIME button (**Droogtijd**)

6 DELAY START button (**Startuitstel**)

7 Display

8 START/PAUSE button (**Start/Pauze**)

9 EXTRA RINSE light

10 TIME MANAGER buttons

PROGRAMME SELECTOR DIAL

It allows you to switch the appliance on/off and/or to select a programme.

TEMPERATURE

This button allows you to increase or decrease the washing temperature.

SPIN SPEED REDUCTION

By pressing this button you can reduce the maximum spin speed allowed for the selected programme or to select the available option(s).

RINSE HOLD

By selecting this function the water of the last rinse is not emptied out to prevent the fabrics from creasing. Before opening the door it will be necessary to empty out the water. To empty out the water, please read the paragraph «At the end of the programme».

AUTOMATIC DRY

By pressing this button you can choose the required degree of drying for cottons and synthetics:

- Extra dry (Cottons)
- Cupboard dry (Cottons and Synthetics)
- Iron dry (Cottons)

The pilot light corresponding to the selected dryness degree will illuminate.

DRYING TIME

If you wish to carry out a timed drying programme, press this button until the drying

time you want appears on the display according to the fabrics (cottons, synthetics or wool) you have to dry.

For Cottons you can select a drying time from 10 minutes to 250 minutes.

For Synthetics you can select a drying time from 10 minutes to 130 minutes.

For Wool you can select a drying time from 10 minutes to 210 minutes.

Every time you press this button the drying time increases by 5 mins.

DELAY START

The programme can be delayed from 30 min - 60 min - 90 min, 2 hours and then by 1 hour up to a maximum of 20 hours by means of this button.

EXTRA RINSE

This appliance is designed to save energy. If it is necessary to rinse the laundry using an extra quantity of water (extra rinse), select this option. Some additional rinses will be performed. This option is recommended for people who are allergic to detergents, and in areas where the water is very soft.

START PAUSE

This button allows you to start or to interrupt the selected programme.

TIME MANAGER

These buttons allow you to modify the programme duration automatically proposed by the appliance.

DISPLAY

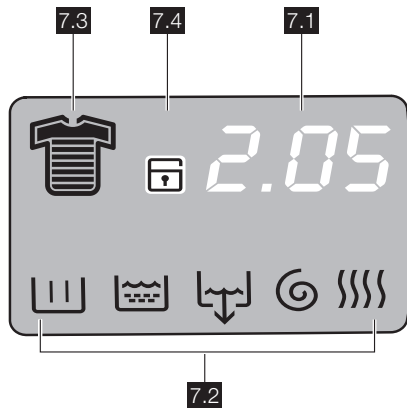

The display shows the following information:

7.1:

- **Duration of the selected programme**
After selecting a programme, the duration is displayed in hours and minutes (for example **2.05**). The duration is calculated automatically on the basis of the maximum recommended load for each type of fabric. After the programme has started, the time remaining is updated every minute.
- **Selected drying time**
After selecting a drying programme, the drying time is displayed in minutes or in hours and minutes (e.g. 130 mins = **2.10**). After the programme has started the time remaining is updated every minute.
- **Delayed start**
The Selected delay set by pressing the relevant button appears on the display for few seconds, then the duration of the selected programme is displayed again.
- **Alarm codes**
In the event of operating problems, some alarm codes can be displayed, for example **E20** (see paragraph «What to do if...»).
- **Incorrect option selection**
If an option which is not compatible with the set wash programme is selected, the message **Err** is displayed at the bottom

of the display for a few seconds and the integrated red light of button **8** start flashing.

- **End of programme**

When the programme has finished three flashing zeros are displayed, the pilot light **9** and the pilot light of button **8** go out and the door can be opened.

7.2: Washing programme phase icons

- Wash
- Rinses
- Drain
- Spin
- Dry

By selecting the wash programme, the washing programme phase icons corresponding to the various phases making up the programme are shown in the bottom part of the display. After having pressed button **8** only the icon of the running phase stays on.

7.3: Soil degree icons

- Intensive
- Normal
- Daily
- Light
- Quick
- Super Quick
- Refresh
- Super Refresh

When selecting a programme on the display appears an icon indicating the degree

of soiling automatically proposed by the machine.













7.4: Child safety lock  (see «Child Safety Lock» paragraph).

TABLE OF SYMBOLS

Programmes Selector dial

	= Time manager programmes
	= Rinse
	= Drain
	= Spin

Buttons and lights

	= Cold
	= Rinse hold
	= Extra dry
	= Store dry
	= Iron dry
	= Child safety lock
	= Extra Rinse
	= Time Manager buttons

FIRST USE

-  • Ensure that the electrical and water connections comply with the installation instructions.
- Remove the polystyrene block and any material from the drum.
- Before the first wash, run a cotton cycle at the highest temperature

without any laundry in the machine, to remove any manufacturing residue from the drum and tub. Pour 1/2 a measure of detergent into the main wash compartment and start the machine.

PERSONALISATION

ACOUSTIC SIGNALS

The machine is provided with an acoustic device, which sounds in the following cases:

- at the end of the cycle
- if there is a fault.

By pressing the **4** and **5** buttons simultaneously for about **6 seconds**, the acoustic signal is deactivated (except if there is a fault). By pressing these 2 buttons again, the acoustic signal is reactivated.

CHILD SAFETY LOCK

This device permits you to leave the appliance unattended and not to worry that children might be injured by or cause damage

to the appliance. This function remains enabled also when the washing machine is not working.

There are two different ways to set this option:

1. Before pressing button **8**: it will be impossible to start the machine.
2. After pressing button **8**: it will be impossible to change any other programme or option.

To enable or disable this option press simultaneously for about 6 seconds buttons **5** and **6** until on the display, the icon  appears or disappears.

DAILY USE

Load the laundry

Open the door by carefully pulling the door handle outwards. Place the laundry in the drum, one item at a time, shaking them out as much as possible. Close the door. Make sure that no laundry stays between the seal and the door. There is a risk of water leakage or damage to the laundry.

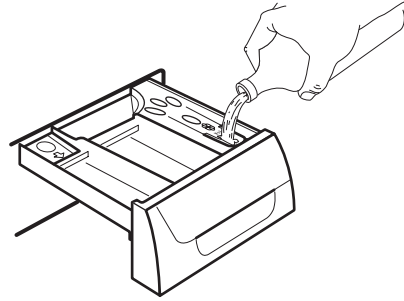

Measure out the detergent and the fabric softener

Pull out the dispenser drawer until it stops. Measure out the amount of detergent required, pour it into the main wash compartment (III) or in the appropriate compartment if the selected programme/option it requires (see more details in «Detergent dispenser drawer»).

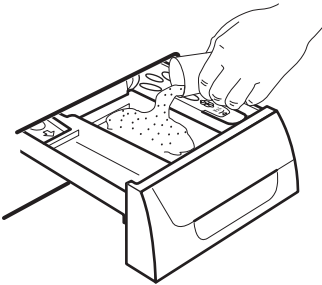

If required, pour fabric softener into the compartment marked ⊗ (the amount used must not exceed the «MAX» mark in the drawer). Close the drawer gently.

SELECT THE REQUIRED PROGRAMME BY TURNING THE PROGRAMME SELECTOR DIAL (1)

Turn the programme selector dial to the required programme. The washing machine will propose a temperature and automatically select the maximum spin value provided for the programme you have chosen. You can change these values by operating the corresponding buttons. The **green** pilot light of the button **8** starts to flash. The selector dial can be turned either clockwise or counterclockwise. Turn to position ○ to reset programme/Switching the machine off.

At the end of the programme the selector dial must be turned to position ○, to switch the machine off.

! Caution! If you turn the programme selector dial to another programme when the machine is working, the **red** pilot light of button **8** will blink 3 times and the message **Err** is displayed to indicate a wrong selection. The machine will not perform the new selected programme.

PROGRAMME OPTION BUTTONS

Depending on the programme, different functions can be combined. These must be selected after choosing the desired programme and before pressing the button **8**.

SELECT THE TEMPERATURE BY PRESSING BUTTON 2

By selecting a programme, the appliance proposes automatically a default temperature.

Press this button repeatedly to increase or decrease the temperature, if you want your laundry to be washed at a different temperature.

REDUCE THE SPIN SPEED BY PRESSING BUTTON 3

By selecting a programme, the appliance proposes automatically the maximum spin speed provided for that programme. Press button **3** repeatedly to change the spin speed, if you want your laundry to be spun at a different speed. The relevant light illuminates.

SELECT THE AVAILABLE OPTION BY PRESSING BUTTONS 3, 4 AND 5

Depending on the selected programme, different functions can be combined before pressing the button **8**. By selecting an option the relevant pilot light illuminates. If an incorrect option is selected, the integrated **red** pilot light of the button **8** flashes 3 times and the **Err** message appears on the display for few seconds.

 For compatibility among the washing programmes and the options see chapter «Washing Programmes».

SELECT AN ADDITIONAL RINSE

This appliance is designed for saving water. However, for people with a very delicate skin (allergic to detergents) it may be necessary to rinse the laundry using an extra quantity of water (Extra Rinse). To **activate** this option press simultaneously the buttons **4** and **6** for some seconds. The pilot light **9** illuminates. This function stays permanently on. To **remove** it press the buttons **4** and **6** again until the pilot light **9** goes off.

SELECT THE DELAY START BY PRESSING BUTTON 6

Before you start the programme, if you wish to delay the start, press the button **6** repeatedly, to select the desired delay. The relevant pilot light goes on.

The selected delay time value (up to 20 hours) will appear on the display a few seconds, then the duration of the programme will appear again.

You must select this option after you have set the programme and before you press button **8**.

You can cancel or modify the delay time at any moment, before you press button **8**.

Selecting the delayed start:

1. Select the programme and the required options.
2. Select the delay start by pressing the button **6**.
3. Press button **8**:
 - the machine starts its hourly countdown.
 - The programme will start after the selected delay has expired.

Cancelling the delayed start after having pressed button **8**:

1. Set the washing machine to PAUSE by pressing button **8**.
2. Press button **6** once until the symbol **0'** is displayed
3. Press button **8** again to start the programme.

Important! The selected delay can be changed only after selecting the washing programme again.

The Delay Start **can not** be selected with **DRAIN** programme.

START THE PROGRAMME BY PRESSING BUTTON 8

To start the selected programme, press the button **8**, the green pilot light of the button **8** stops blinking.

To interrupt a programme which is running, press the button **8**: the green pilot light starts blinking.

To restart the programme from the point at which it was interrupted, press the button **8** **again**. If you have chosen a delayed start, the machine will begin the countdown. If an incorrect option is selected, the **red** pilot light of the button **8** blinks for 3 times the message **Err** is displayed for a few seconds.

SELECT THE TIME MANAGER OPTION BY PRESSING BUTTONS 10

By pressing these buttons repeatedly, the duration of the washing cycle can be increased or decreased. The soil level icon will appear on the display to indicate the chosen degree of soil. This option is available only with **Cotton**, **Synthetic** and **Delicate** programmes.

Soil Level	Icon	Type of fabric
Intensive		For heavy soiled items
Normal		For normal soiled items
Daily		For daily soiled items
Light		For slightly soiled items
Quick		For very slightly soiled items
Super Quick ¹⁾		For items used or worn for a short time
Refresh ¹⁾		For refreshing items only
Super Refresh ¹⁾		For refreshing a very few items only

1) We recommend you to reduce the load sizes (see Washing programmes table).

2) When you select this option the relevant icon appears just for a while and then it disappears immediately.

ALTERING AN OPTION OR A RUNNING PROGRAMME

It is possible to change some options before the programme carries them out. Before you make any change, you must PAUSE the appliance by pressing the button **8** (if you wish to change the Time Manager option, you must cancel the running programme and make your selection again).

Changing a running programme is possible only by resetting it. Turn the programme selector dial to  and then to the new programme position. Start the new programme by pressing the button **8** again. The washing water in the tub will be not emptied out.

INTERRUPTING A PROGRAMME

Press the button **8** to interrupt a programme which is running, the corresponding green pilot light starts blinking.

Press the button again to **restart** the programme.

CANCELLING A PROGRAMME

Turn the selector dial to  to cancel a programme which is running.

You can select now a new programme.

OPENING THE DOOR

After the programme has started and through the delay time the door is locked. If for any reason, you need to open it, set firstly the machine to PAUSE by pressing the button **8**.

After a few minutes it will be possible to open the door.

If the door remains locked, this means that the machine is already heating or that the water level is too high. In any case, do not try to force the door!

If you cannot open the door but you need to open it you have to switch the machine off by turning the selector dial to **O**. After a few minutes the door can be opened (**pay attention to the water level and temperature!**).

After closing the door, it is necessary to select the programme and options again and to press button **8**.

AT THE END OF THE PROGRAMME

The machine stops automatically. Three blinking **0.00** appear on the display and the pilot light of button **8** goes off. Some acoustic signals sound.

If a programme or an option that ends with water left in the tub has been selected, the door remains locked to indicate that the water must be emptied out before opening the door.

Before you empty out the water, the drum continues to run at regular intervals until the water draining.

Follow the below instructions to empty out the water:

1. Turn the programme selector dial to **O**.
2. Select the draining or spinning programme.

3. Reduce the spin speed if needed, by pressing the relevant button.
4. Press button **8**.

At the end of the programme, the door is released and can be opened. Turn the programme selector dial to **O** to switch the machine off.

Remove the laundry from the drum and carefully check that the drum is empty. If you do not intend to carry out another wash, close the water tap. Leave the door open to prevent the formation of mildew and unpleasant smells.

Stand by : once the programme has finished after a few minutes the energy saving system will be enabled. The brightness of

the display is reduced. By pressing any button the appliance will come out of the energy saving status.

USE - DRYING

DRYING ONLY

Warning!

The recommended load size is 3.5 kg for cottons and linen, 2 kg for synthetic items and 1.5 kg for wool.

Important! For wool items the timed drying is the only drying available (Drying Time button).

 By pressing **Drying Time** button it is also possible to dry up to 5 kg of cotton items (see the «Drying Programme » table).

Warning!

The water tap must be open and the drain hose must be positioned in the sink or connected to the drain pipe.

1. Load the laundry.
2. Select a spin cycle at the maximum spin speed allowed for the type of laundry in order to obtain the best drying performances.
3. Select the drying programme for Cottons, Synthetic or Wool in the Drying sector of the programme selector dial.
4. If you wish to select an **automatic drying** (for cottons and synthetic items only), press the button **4** until the light corresponding to the required dryness degree illuminates.

5. If you wish to select a **timed drying**, press the button **5** until the time you want appears on the display (see the «Drying Programme» table). Every time you press this button the drying time increases by 5 minutes.

Note!

The programme time will automatically increase by some minutes.

6. Press button **8** to start the programme. The time remaining is updated every minute.
7. At the end of the programme, the buzzer sounds. Three blinking «**0.00**» zeros appear on the display. During the last 10 minutes of the drying cycle the appliance performs an anti-crease phase. Through this time the door is locked. The display shows three flashing zeros «**0.00**».

 If you wish to open the door before or during the anti-crease phase or to interrupt it, press any button or turn the programme selector dial to any programme position (except **O**).

8. Turn the selector dial to the **O** position to switch the machine off.
9. Remove the laundry from the drum.

Note!

The different type of cottons (towelling, sheets, shirts, and so on) or any laundry items rolling up during the spinning phase may result in partial dryness. In the exceptional case that at the end of the cycle the laundry remains slightly wet, we suggest that you unfold the rolled up items, redistribute them evenly in the drum and select an additional drying cycle of 20-30 minutes.

Important!

If you set only 10 minutes of drying phase with the drying time button (5), the appliance performs only a cooling phase.

USE - WASHING & DRYING

NON-STOP PROGRAMME - WASHING AND AUTOMATIC DRYING

The maximum load size is 3.5 kg for cotton and 2 kg for synthetic.

 **Caution! Do not use a dosing device/ball when carrying out a washing and drying programme.**

1. Load the laundry.
2. Add detergent and fabric softener.
3. Switch the machine on by turning the selector dial to the set washing programme/fabric.
4. Select the required options by pressing the relevant buttons.

If possible, do not select a spin speed lower than that proposed by the appliance to avoid too long a drying time therefore saving energy.

In any case the reduction of the spin speed is only possible after selecting drying.

For cottons and synthetic the lowest value you can select is 900 r.p.m.

5. Set the dryness degree by pressing button 4. The display shows the whole duration of the washing and the set drying cycle.
6. Start the programme by pressing button 8. The time remaining is updated every minute on the display.
7. At the end of the programme turn the selector dial to the **O** position to switch the machine off. Remove the laundry.

NON-STOP PROGRAMME - WASHING AND TIMED DRYING

The recommended load size is 3.5 kg for cotton, 2 kg for synthetic and 1.5 for wool.

 By pressing Drying Time button it is also possible to dry up to 5 kg of cotton items (see the «Drying Programme » table).

 **Caution! Do not use a dosing device/ball when carrying out a washing and drying programme.**

1. Load the laundry and add detergent and fabric softener.
2. Switch the machine on by turning the selector dial to the set washing programme/fabric.
3. Select the required options by pressing the relevant buttons.

If possible, do not select a spin speed lower than that proposed by the appliance to avoid too long a drying time therefore saving energy.

In any case the reduction of the spin speed is only possible after selecting drying.

The lowest values you can select are the following:

- 900 r.p.m. for cottons and synthetics and 700 r.p.m. for delicate fabrics
 - 900 r.p.m. (or 1000 r.p.m. depending on the model) for wool.
4. Set the drying time by pressing button 5. The display shows the whole duration of the washing and the set drying cycle.

-  If you set only 10 minutes of drying phase at the end of the wash, the display shows the total duration of the programme that includes also the unrolling and the cooling phase.
5. Start the programme by pressing button 8. The time remaining is updated every minute on the display.
 6. At the end of the programme turn the selector dial to the **O** position to switch the machine off and remove the laundry.

FLUFF IN THE GARMENTS

During the WASHING AND/OR DRYING PHASE, certain types of fabric, as sponge-cloth, wool, sweatshirt, could release fluff. The released fluff could stick to the fabrics during the next cycle.

This drawback increases with technical fabrics.

To prevent the lint in your clothes, it is recommended:

- To do not wash dark fabrics after you washed and dried light colored fabrics

(new sponge, wool, sweatshirt especially) and vice versa.

- To air-dry this type of fabrics when they are washed the first time.
- To clean the filter.
- Perform one or more rinse cycles to wash the drum between the washing and drying of fabrics with different colors.
- After the drying phase, thoroughly clean the empty drum, the gasket and the door with a wet rag.

HELPFUL HINTS AND TIPS

SORTING OUT THE LAUNDRY

Follow the wash code symbols on each garment label and the manufacturer's washing instructions. Sort the laundry as follows: whites, coloureds, synthetics, delicates, woollens.

TEMPERATURES

95° or 90°	for normally soiled white cottons and linen (e.g. tea cloths, towels, tablecloths, sheets...)
60°/50°	for normally soiled, colour fast garments (e.g. shirts, night dresses, pyjamas....) in linen, cotton or synthetic fibres and for lightly soiled white cotton (e.g. underwear)
40°-30°- Cold	for delicate items (e.g. net curtains), mixed laundry including synthetic fibres and woollens bearing the label «pure new wool, machine washable, non-shrink»

BEFORE LOADING THE LAUNDRY

Never wash whites and coloureds together. Whites may lose their «whiteness» in the wash.

New coloured items may run in the first wash; they should therefore be washed separately the first time.

Make sure that no metal objects are left in the laundry (e.g. hair clips, safety pins, pins).

Button up pillowcases, close zip fasteners, hooks and poppers. Tie any belts or long tapes.

Remove persistent stains before washing.

Rub particularly soiled areas with a special detergent or detergent paste.

Treat curtains with special care. Remove hooks or tie them up in a bag or net.

MAXIMUM LOADS

Recommended loads are indicated in the washing programme charts.

General rules:

- **Cotton, linen:** drum full but not too tightly packed;
- **Synthetics:** drum no more than half full;
- **Delicate fabrics and woollens:** drum no more than one third full.

Washing a maximum load makes the most efficient use of water and energy.

For heavily soiled laundry, reduce the load size.

LAUNDRY WEIGHTS

The following weights are indicative:

The following weights are indicative:	
bathrobe	1200 g
quilt cover	700 g
man's work shirt	600 g
sheet, man's pyjamas	500 g
tablecloth	250 g
pillow case, towelling towel, night dress, man's shirt	200 g
tea cloth, ladies' briefs, napkin, blouse, men's under-pants	100 g

REMOVING STAINS

Stubborn stains may not be removed by just water and detergent. It is therefore advisable to treat them prior to washing.

Blood: treat fresh stains with cold water. For dried stains, soak overnight in water with a special detergent then rub in the soap and water.

Oil based paint: moisten with benzine stain remover, lay the garment on a soft cloth and dab the stain; treat several times.

Dried grease stains: moisten with turpentine, lay the garment on a soft surface and dab the stain with the fingertips and a cotton cloth.

Rust: oxalic acid dissolved in hot water or a rust removing product used cold. Be careful with rust stains which are not recent since the cellulose structure will already have been damaged and the fabric tends to hole.

Mould stains: treat with bleach, rinse well (whites and fast coloureds only).

Grass: soap lightly and treat with bleach (whites and fast coloureds only).

Ball point pen and glue: moisten with acetone¹⁾, lay the garment on a soft cloth and dab the stain.

Lipstick: moisten with acetone as above, then treat stains with methylated spirits. Treat any residual marks with bleach.

Red wine: soak in water and detergent, rinse and treat with acetic or citric acid, then rinse. Treat any residual marks with bleach.

Ink: depending on the type of ink, moisten the fabric first with acetone¹⁾, then with acetic acid; treat any residual marks on white fabrics with bleach and then rinse thoroughly.

Tar stains: first treat with stain remover, methylated spirits or benzine, then rub with detergent paste.

DETERGENTS AND ADDITIVES

Good washing results also depend on the choice of detergent and use of the correct quantities to avoid waste and protect the environment.

Although biodegradable, detergents contain substances which, in large quantities, can upset the delicate balance of nature.

The choice of detergent will depend on the type of fabric (delicates, woollens, cottons,

etc.), the colour, washing temperature and degree of soiling.

All commonly available washing machine detergents may be used in this appliance:

- powder detergents for all types of fabric
- powder detergents for delicate fabrics (60°C max) and woollens
- liquid detergents, preferably for low temperature wash programmes (60°C max) for all types of fabric, or special for woollens only.

The detergent and any additives must be placed in the appropriate compartments of the dispenser drawer before starting the wash programme.

If using liquid detergents, a programme **without** prewash must be selected.

Your appliance incorporates a recirculation system which allows an optimal use of the concentrated detergent.

Follow the product manufacturer's recommendations on quantities to use and do **not exceed the «MAX» mark in the detergent dispenser drawer.**

DEGREES OF WATER HARDNESS

Water hardness is classified in so-called "degrees" of hardness. Information on hardness of the water in your area can be obtained from the relevant water supply company, or from your local authority.

i A water softener must be added when water has a medium-high degree of hardness (from degree of hardness II). Follow the manufacturer's instructions. The quantity of detergent can then always be adjusted to degree of hardness I (= soft).

Level	Characteristic	Degrees of water hardness	
		German °dH	French °T.H.
1	soft	0-7	0-15
2	medium	8-14	16-25
3	hard	15-21	26-37
4	very hard	> 21	> 37

¹⁾ do not use acetone on artificial silk

DRYING HINTS

PREPARING THE DRYING CYCLE

As a dryer, the appliance works on the condensation principle.

Therefore, the water tap must be open and the drain hose must drain water into a sink or into the drain pipe, even during the drying cycle.

Attention!

Before starting the drying programme, reduce the loads of washed laundry, in order to obtain good performances.

LAUNDRY NOT SUITABLE FOR DRYING

- Particularly delicate items such as synthetic curtains, woollen and silk, garments with metal inserts, nylon stockings, bulky garments such as anoraks, bed covers, quilts, sleeping bags and duvets must not be machine dried.
- Avoid drying dark clothes with light coloured fluffy items such as towels as these can attract the fluff.
- Remove the laundry when the appliance has finished drying.
- To avoid a static charge when drying is completed, use either a fabric softener when you are washing the laundry or a fabric conditioner specifically for tumble dryers.
- Garments padded with foam-rubber or materials similar to foam-rubber must not be machine dried; they represent a fire hazard.
- Also, fabrics containing residue of setting lotions or hair sprays, nail solvents or similar solutions must not be machine dried in order to avoid the formation of harmful vapours.





The detergent and any additives must be placed in the appropriate compartments of the dispenser drawer before starting the wash programme.

If using liquid detergents, a programme **without** prewash must be selected. Your appliance incorporates a re-circulation system which allows an optimal use of the concentrated detergent.

Follow the product manufacturer's recommendations on quantities to use and do **not exceed the «MAX» mark in the detergent dispenser drawer.**

GARMENT LABELS

For drying, follow the indications given on the manufacturer's labels:

-  = May be tumble dried
-  = Drying at high temperature
-  = Drying at reduced temperature
-  = Do not tumble dry.

DRYING CYCLE DURATION

The drying time may vary depending on:

- speed of the final spin
- dryness degree required (iron dry, store dry)
- type of laundry
- weight of the load size .

The average drying time for a timed drying are indicated in the «Drying programmes» chapter. The experience will help you to dry your laundry in a more suitable way, according to the different fabrics. Take note of the duration drying time of the already performed cycles.













ADDITIONAL DRYING



If the laundry is still damp at the end of the drying programme, select a short drying cycle again.



Warning! Do not over dry the laundry in order to avoid creasing of fabrics or garment's shrinking.

WASHING PROGRAMMES

Programme - Maximum and Minimum Temperature - Cycle Description - Maximum Spin Speed - Maximum Fabrics Load - Type of Laundry	Options	Detergent Com- partment
Katoen 90° - Cold Main wash - Rinses Spin at the maximum speed Max. load 7 kg - Reduced load 3.5 kg White and coloured cotton (normally soiled items).	SPIN REDUCTION RINSE HOLD EXTRA RINSE TIME MANAGER ¹⁾	 
Katoen + Voorwas 90° - Cold Prewash - Main wash - Rinses Spin at the maximum speed Max. load 7 kg - Reduced load 3.5 kg White or coloured cottons with prewash phase (heavily soiled items).	SPIN REDUCTION RINSE HOLD EXTRA RINSE TIME MANAGER ¹⁾	 ²⁾  
Synthetica 60° - Cold Main wash - Rinses Maximum spin speed at 900 rpm Max. load 3.5 kg - Reduced load 2 kg Synthetic or mixed fabrics: underwear, coloured garments, non-shrink shirts, blouses.	SPIN REDUCTION RINSE HOLD EXTRA RINSE TIME MANAGER ¹⁾	 
Fijne was 40° - Cold Main wash - Rinses Maximum spin speed at 700 rpm Max. load kg 3.5 - Reduced load kg 2 Delicate fabrics: acrylics, viscose, polyester.	RINSE HOLD EXTRA RINSE TIME MANAGER ¹⁾	 
Wol / Handwas   40° - Cold Main wash - Rinses Maximum spin speed at 900 rpm Max. load 2 kg Washing programme for machine washable wool as well as for hand washable woollens and delicate fabrics.	SPIN REDUCTION RINSE HOLD	 
Zijde 30° - Cold Main wash - Rinses Maximum spin speed at 700 rpm Max. load 1 kg Delicate washing programme suitable for silk and mixed synthetic items.	RINSE HOLD	 

Programme - Maximum and Minimum Temperature - Cycle Description - Maximum Spin Speed - Maximum Fabrics Load - Type of Laundry	Options	Detergent Compartment
<p>Rinse Rinse - Long spin Spin at the maximum speed Max. load 7 kg With this programme it is possible to rinse and spin cotton garments which have been washed by hand. To intensify the rinsing action, select the option EXTRA RINSE. The appliance will add some additional rinses.</p>	SPIN REDUCTION RINSE HOLD EXTRA RINSE	
<p>Drain Draining of water Max. load 7 kg For emptying out the water of the last rinse in programmes with the option selected, which ends with water left in the tub.</p>		
<p>Spin Drain and long spin Spin at the maximum speed Max. load 7 kg Separate spin for hand washed garments and after programmes with the option selected, which ends with water left in the tub. You can choose the spin speed by pressing the relevant button to adapt it to the fabrics to be spun.</p>	SPIN REDUCTION	
<p>Katoen Eco 90° - 40° Main wash - Rinses Spin at the maximum speed Max. load 7 kg White and fast coloured cotton. This programme can be selected for slightly or normally soiled cotton items. The temperature will decrease and the washing time will be extended. This allows to obtain a good washing efficiency so saving energy.</p>	SPIN REDUCTION RINSE HOLD EXTRA RINSE	
<p>Dekens 40° - 30° Main wash - Rinses Maximum spin speed at 700 rpm Max. load 2.5 kg For a single washable synthetic blanket or duvet.</p>		
<p>Drogen - Wol Drying wool programme. It can be used with timed drying only.</p>		
<p>Drogen - Synthetica Drying synthetic programme. It can be used with timed drying or with automatic drying (dryness degree: store dry).</p>		
<p>Drogen - Katoen Drying cotton programme. It can be used with timed drying or with automatic drying (dryness degree: extra dry, store dry, iron dry).</p>		

Programme - Maximum and Minimum Temperature - Cycle Description - Maximum Spin Speed - Maximum Fabrics Load - Type of Laundry	Options	Detergent Compartment
O = Off For cancelling the programme which is running or to switch the machine off .		

- 1) If you select the Super Quick option by pressing the buttons **10**, we recommend that you reduce the maximum load as indicated in this chart. Full loading is possible however with somewhat reduced cleaning results. If you select the Refresh or Super Refresh option, we recommend that you reduce the load even more.
- 2) If using liquid detergents, a programme without PREWASH must be selected.

DRYING PROGRAMMES

AUTOMATIC PROGRAMMES

Degree of Drying	Type of Fabric	Max Load
EXTRA DRY Ideal for towelling materials	Cotton and linen (bathrobes, bath towels, etc)	3.5 kg
STORE DRY Suitable for items to put away without ironing	Cotton and linen (bathrobes, bath towels, etc)	3.5 kg
STORE DRY Suitable for items to put away without ironing	Synthetics and mixed fabrics (jumpers, blouses, underwear, household linen)	2 kg
IRON DRY Suitable for ironing	Cotton and linen (sheets, tablecloths, shirts, etc.)	3.5 kg

TIMED PROGRAMMES

Degree of Drying	Type of Fabric	Drying Load	Spin Speed (rpm)	Suggested drying time (minutes)
EXTRA DRY Ideal for towelling materials	Cotton and linen (bathrobes, bath towels, etc)	5 kg 3.5 kg 1.5 kg	1600	175-195 95-105 40-50
STORE DRY Suitable for items to put away without ironing	Cotton and linen (bathrobes, bath towels, etc)	5 kg 3.5 kg 1.5 kg	1600	165-185 85-95 35-45
STORE DRY Suitable for items to put away without ironing	Synthetics and mixed fabrics (jumpers, blouses, underwear, household linen)	2 kg 1 kg	900	70-80 35-45
IRON DRY Suitable for ironing	Cotton and linen (sheets, tablecloths, shirts, etc.)	5 kg 3.5 kg 1.5 kg	1600	135-155 65-75 30-40
WOOL DRY¹⁾	Wool (jumpers)	1.5 Kg	900	140-170

Hints for test institute

Test performance, in accordance with EN 50229, must be carried out with the a first drying load of 4 kg (load composition : pillowcase and towels) by selecting the TIMED DRYING programme for Cotton and setting 100 minutes.

The second drying load of 3 kg (load composition : 3 sheets and towels) must be tested by selecting the TIMED DRYING programme for Cotton and setting 85 minutes.

1) Woolmark approved both wool wash and dry programmes.

CARE AND CLEANING

Warning! You must disconnect the appliance from the electricity supply, before you can carry out any cleaning or maintenance work.

DESCALING

The water we use normally contains lime. It is a good idea to periodically use a water softening powder in the machine. Do this separately from any laundry washing, and according to the softening powder manufacturer's instructions. This will help to prevent the formation of lime deposits.

AFTER EACH WASH

Leave the door open for a while. This helps to prevent mould and stagnant smells forming inside the appliance. Keeping the door open after a wash will also help to preserve the door seal.

MAINTENANCE WASH

With the use of low temperature washes it is possible to get a build up of residues inside the drum.

We recommend that a maintenance wash be performed on a regular basis.

To run a maintenance wash:

- The drum should be empty of laundry.
- Select the hottest cotton wash programme.
- Use a normal measure of detergent, must be a powder with biological properties.

EXTERNAL CLEANING

Clean the exterior cabinet of the appliance with soap and water only, and then dry thoroughly.

Important! Do not use methylated spirits, solvents or similar products to clean the cabinet.

CLEANING THE DISPENSER DRAWER

The detergent dispenser drawer should be cleaned regularly.

The washing powder and additive dispenser drawer should be cleaned regularly.

Remove the drawer by pressing the catch downwards and by pulling it out.

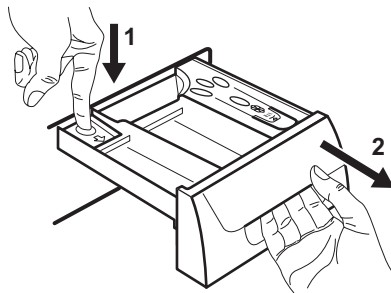

Flush it out under a tap, to remove any traces of accumulated powder. To aid cleaning, the top part of the additive compartment should be removed. Clean all parts with water.

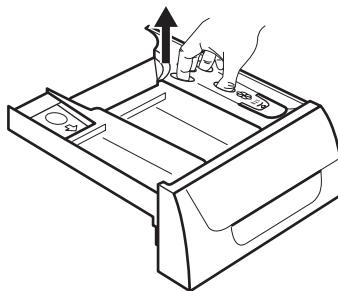

Clean the chamber of dispenser drawer with a brush.

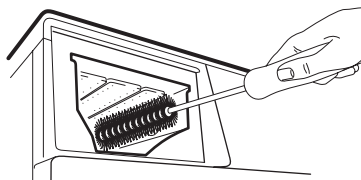

WASHING DRUM

Rust deposits in the drum may occur due to rusting foreign bodies in the washing or tap water containing iron.

Important! Do not clean the drum with acidic descaling agents, scouring agents containing chlorine or iron or steel wool.

1. Remove any rust deposits on the drum with a cleaning agent for stainless steel.

- Run a washing cycle without any washing to clean off any cleaning agent residues.
Programme: Short Cotton Programme at maximum temperature and add approx. 1/4 measuring cup of detergent.

DOOR SEAL

Check from time to time the door seal and eliminate eventual possible objects that could be trapped in the fold.

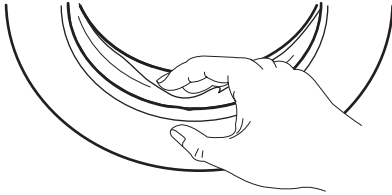

DRAIN PUMP

Regularly examine the drain pump and make sure that it is clean.

Clean the pump regularly and/or if:

- The appliance does not drain the water.
- The drum cannot turn.
- The appliance makes an unusual noise because of the blockage of the drain pump.
- A problem with water draining is detected (see chapter "What to do if..." for more details).

⚠ Warning!

- Disconnect the mains plug from the mains socket.
- Do not remove the filter while the appliance operates. Do not clean the drain pump if the water in the appliance is hot. The water must be cold before you clean the drain pump.

To clean the drain pump:

- Open the pump door.

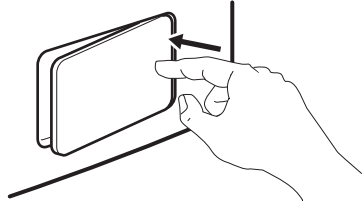

- Put a container below the recess of the drain pump to collect the water that flows out.
- Press the two levers and pull forward the drainage duct to let the water flow out.

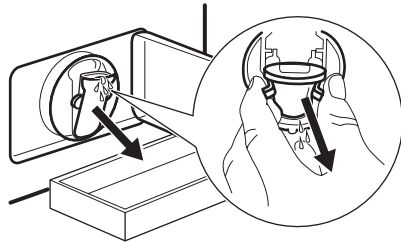

- When the container is full of water, put the drainage duct back again and empty the container. Do steps 3 and 4 again and again until no more water flows out from the drain pump.

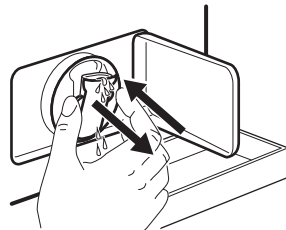

- Pull back the drainage duct.
- Unscrew the filter and remove it.

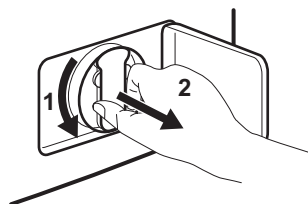

- Remove fluff and objects from the pump.

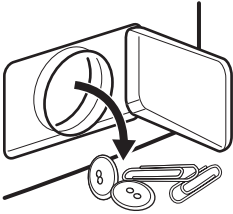

- Make sure that the impeller of the pump can turn. If this does not occur, contact the service centre.

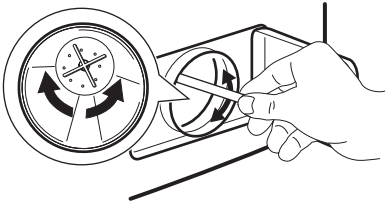

- Clean the filter under the water tap and put it back in the pump into the special guides.
- Make sure that you tighten correctly the filter to prevent leakages.

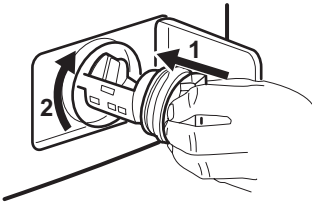

- Close the drain pump door.

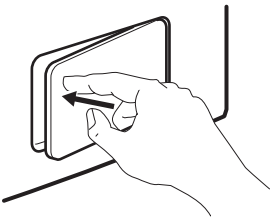

Warning!

Never remove the pump cover during a wash cycle, always wait until the appliance has finished the cycle, and is empty. When refitting the pump cover, ensure it is se-

curely re-tightened so as to stop leaks and young children being able to remove it.

CLEANING THE WATER INLET FILTERS

If you notice that the machine is taking longer to fill, check that the filter in the water inlet hose is not blocked.

- Turn off the water tap.
- Unscrew the water inlet hose.
- Clean the filter in the hose using a hard bristle brush.

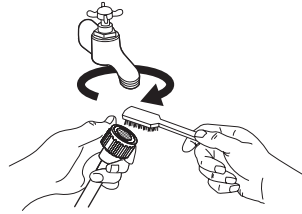

- Screw the hose back onto the tap.
- Unscrew the hose from the machine. Keep a rug nearby because some water may flow.
- Clean the filter in the valve with a stiff brush or with the piece of cloth.

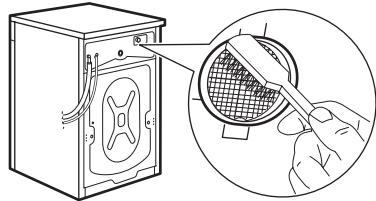

- Screw the hose back to the machine and make sure the connection is tight.
- Turn on the water tap.

EMERGENCY EMPTYING OUT

If the appliance cannot drain the water, proceed as follows to empty out the machine:

- pull out the plug from the power socket;
- close the water tap;
- if necessary, wait until the water has cooled down;
- open the pump door;
- place a container on the floor below the recess of the drain pump;

6. press the two levers and pull forward the drainage duct to let the water flow out;
7. when the container is full of water, put the drainage duct back again and empty the container; repeat this operation until water stops flowing out;
8. if necessary clean the pump (refer to the section 'Drain pump');
9. close the drain pump door.

When you drain the water with the emergency drain procedure, you must activate again the drain system:

1. Put 2 litres of water in the main wash compartment of the detergent dispenser.
2. Start the programme to drain the water.

FROST PRECAUTIONS

If the machine is installed in a place where the temperature could drop below 0°C, re-

move the remaining water from the inlet hose and the drain pump.

1. disconnect the mains plug from the mains socket.
2. close the water tap
3. unscrew the water inlet hose from the tap;
4. put the two ends of the inlet hose in a container and let the water flow out of the hose.
5. empty the drain pump as described in the 'Emergency drain' section.
6. when the drain pump is empty, install the water inlet hose again.

Warning!

Make sure that the temperature is more than 0 °C before you use the appliance again.

The manufacturer is not responsible for damages caused by low temperatures.

WHAT TO DO IF...

Certain problems are due to lack of simple maintenance or oversights, which can be solved easily without calling out an engineer. Before contacting your local Service Centre, please carry out the checks listed below.

During machine operation it is possible that the **red** pilot light of button **8** blinks, one of the following alarm codes appears on the display and some acoustic signals sound

every 20 seconds to indicate that the machine is not working:

- **E10** : problem with the water supply.
- **E20** : problem with the water draining.
- **E40** : door open.

Once the problem has been eliminated, press the button **8** to restart the programme. If after all checks, the problem persists, contact your local Service Centre.

Problem	Possible cause/Solution
<p>The washing machine does not start:</p>	<p>The door has not been closed. E40</p> <ul style="list-style-type: none"> • Close the door firmly. <p>The plug is not properly inserted in the power socket.</p> <ul style="list-style-type: none"> • Insert the plug into the power socket. <p>There is no power at the socket.</p> <ul style="list-style-type: none"> • Please check your domestic electrical installation. <p>The main fuse has blown.</p> <ul style="list-style-type: none"> • Replace the fuse. <p>The selector dial is not correctly positioned and/or the button 8 has not been pressed.</p> <ul style="list-style-type: none"> • Please turn the selector dial and press the button 8 again. <p>The delay start has been selected.</p> <ul style="list-style-type: none"> • If the laundry are to be washed immediately, cancel the delay start. <p>The Child Safety Lock has been activated.</p> <ul style="list-style-type: none"> • Deactivate the Child Safety Lock.

Problem	Possible cause/Solution
The machine does not fill:	<p>The water tap is closed. <i>E10</i></p> <ul style="list-style-type: none"> • Open the water tap. <p>The inlet hose is squashed or kinked. <i>E10</i></p> <ul style="list-style-type: none"> • Check the inlet hose connection. <p>The filter in the inlet hose or in the inlet valve filter are blocked. <i>E10</i></p> <ul style="list-style-type: none"> • Clean the water inlet filters (see 'Cleaning the water inlet filters' for more details). <p>The door is not properly closed. <i>E40</i></p> <ul style="list-style-type: none"> • Close the door firmly.
The machine fills then empties immediately:	<p>The end of the drain hose is too low.</p> <ul style="list-style-type: none"> • Refer to relevant paragraph in «Water drainage» section.
The machine does not empty and/or does not spin:	<p>The drain hose is squashed or kinked. <i>E20</i></p> <ul style="list-style-type: none"> • Check the drain hose connection. <p>The drain filter is clogged. <i>E20</i></p> <ul style="list-style-type: none"> • Clean the drain filter. <p>An option or a programme that ends with the water still in the tub or that eliminates all the spinning phases has been selected.</p> <ul style="list-style-type: none"> • Select the draining or spinning programme. <p>The laundry is not evenly distributed in the drum.</p> <ul style="list-style-type: none"> • Redistribute the laundry.
There is water on the floor:	<p>Too much detergent or unsuitable detergent (creates too much foam) has been used.</p> <ul style="list-style-type: none"> • Reduce the detergent quantity or use another one. <p>Check whether there are any leaks from one of the inlet hose fittings. It is not always easy to see this as the water runs down the hose; check to see if it is damp.</p> <ul style="list-style-type: none"> • Check the water inlet hose connection. <p>The drain or inlet hose is damaged.</p> <ul style="list-style-type: none"> • Replace it with a new one. <p>The filter has not been properly screwed in after cleaning action.</p> <ul style="list-style-type: none"> • Screw the filter fully in.
Unsatisfactory washing results:	<p>Too little detergent or unsuitable detergent has been used.</p> <ul style="list-style-type: none"> • Increase the detergent quantity or use another one. <p>Stubborn stains have not been treated prior to washing.</p> <ul style="list-style-type: none"> • Use commercial products to treat the stubborn stains. <p>The correct temperature was not selected.</p> <ul style="list-style-type: none"> • Check if you have selected the correct temperature. <p>Excessive laundry load.</p> <ul style="list-style-type: none"> • Reduce the laundry load.
The door will not open:	<p>The programme is still running.</p> <ul style="list-style-type: none"> • Wait the end of washing cycle. <p>The door lock has not been released.</p> <ul style="list-style-type: none"> • Wait until the door is released. <p>There is water in the drum.</p> <ul style="list-style-type: none"> • Select drain or spin programme to empty out the water.
The machine vibrates is noisy:	<p>The transit bolts and packing have not been removed.</p> <ul style="list-style-type: none"> • Check the correct installation of the appliance. <p>The support feet have not been adjusted</p> <ul style="list-style-type: none"> • Check the correct levelling of the appliance. <p>The laundry is not evenly distributed in the drum.</p> <ul style="list-style-type: none"> • Redistribute the laundry. <p>Maybe there is very little laundry in the drum.</p> <ul style="list-style-type: none"> • Load more laundry.

Problem	Possible cause/Solution
Spinning starts late or the machine does not spin:	<p>The electronic unbalance detection device has cut in because the laundry is not evenly distributed in the drum. The laundry is redistributed by reverse rotation of the drum. This may happen several times before the unbalance disappears and normal spinning can resume. If, after 10 minutes, the laundry is still not evenly distributed in the drum, the machine will not spin. In this case, redistribute the load manually and select the spin programme.</p> <ul style="list-style-type: none"> • Redistribute the laundry. <p>The load is too small.</p> <ul style="list-style-type: none"> • Add more items, redistribute the load manually and then select the spinning programme.
The machine makes an unusual noise:	<p>The machine is fitted with a type of motor which makes an unusual noise compared with other traditional motors. This new motor ensures a softer start and more even distribution of the laundry in the drum when spinning, as well as increased stability of the machine.</p>
No water is visible in the drum:	<p>Machines based on modern technology operate very economically using very little water without affecting performance.</p>
The machine does not dry or does not dry properly:	<p>The drying time or the dryness degree has not been selected.</p> <ul style="list-style-type: none"> • Select the drying time or the dryness degree. <p>The water tap is not turned on. <i>E10</i></p> <ul style="list-style-type: none"> • Open the water tap. <p>The drain filter is clogged. <i>E20</i></p> <ul style="list-style-type: none"> • Clean the drain filter. <p>The machine is overloaded.</p> <ul style="list-style-type: none"> • Reduce the laundry load in the drum. <p>The selected drying programme, time or dryness degree was not suitable for the laundry.</p> <ul style="list-style-type: none"> • Select the suitable drying programme, time or dryness degree for the laundry.
The laundry is full of different colored fluff:	<p>The fabrics washed in the previous cycle released fluff of a different color (refer to "Fluff in the garments" in chapter "Use - Washing & Drying").</p> <ul style="list-style-type: none"> • The drying phase helps to eliminate some fluff. • Clean the clothes with a fluff remover. <p>In case of an excessive amount of fluff in the drum repeat the following procedure twice:</p> <ul style="list-style-type: none"> • Thoroughly clean the empty drum, the gasket and the door with a wet rag. • Perform a rinse cycle. • Put a wool or piled fabric rag inside the drum. • Perform a drying cycle of 10 minutes. • Remove the old wool cloth. <p>Now you can wash other garments.</p>

If you are unable to identify or solve the problem, contact our service centre. Before telephoning, make a note of the model, serial number and purchase date of your machine: the Service Centre will require this information.

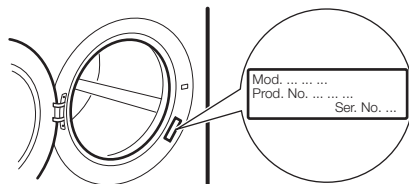

TECHNICAL DATA

Dimensions	Width Height Depth	60 cm 85 cm 63 cm
Electrical connection Voltage - Overall power - Fuse	Information on the electrical connection is given on the rating plate, on the inner edge of the appliance door.	
Water Supply Pressure	Minimum Maximum	0,05 MPa 0,8 MPa
Maximum Load	Cotton	7 kg
Maximum Dry Load	Cotton Cotton Big Capacity Synthetic	3.5 Kg 5 Kg 2 Kg
Spin Speed	Maximum	1600 rpm

CONSUMPTION VALUES

Programme	Energy consumption (KWh)	Water consumption (litres)	Programme duration (Minutes)
White Cottons 90°	2.20	67	For the duration of the programmes, please refer to the display on the control panel.
Cottons 60°	1.35	63	
Cotton Energy Saving Programme 60° ¹⁾	1.05	45	
Cottons 40°	0.80	63	
Synthetics 40°	0.55	51	
Delicates 40°	0.55	63	
Wool/ Handwash 30°	0.25	58	

1) «Cotton Energy Saving programme » at 60°C with a load of 7 kg is the reference programme for the data entered in the energy label, in compliance with EEC 92/75 standards.

i The consumption data shown on this chart is to be considered purely indicative, as it may vary depending on the quantity and type of laundry, on the inlet water temperature and on the ambient temperature.

INSTALLATION

UNPACKING

All transit bolts and packing must be removed before using the appliance. You are advised to keep all transit devices so that they can be refitted if the machine ever has to be transported again.

1. After removing all the packaging, carefully lay machine on it's back to remove the polystyrene base from the bottom.

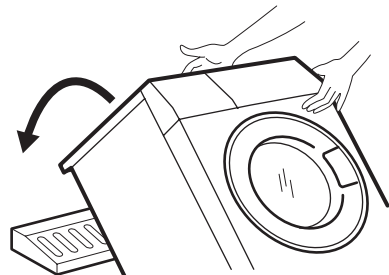

2. Remove the power supply cable and the draining and inlet hose from the hose holders on the rear of the appliance.

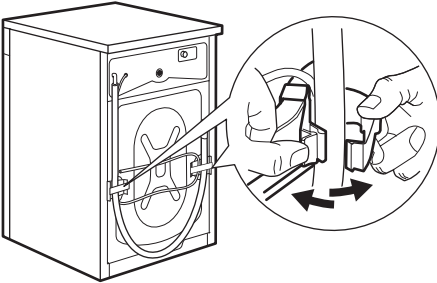

3. Unscrew the three bolts with the supplied spanner.

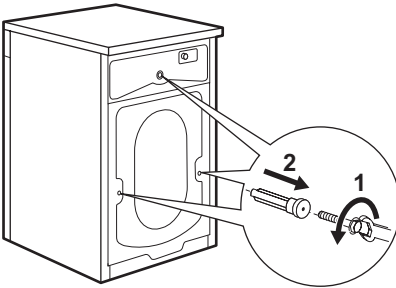

4. Slide out the relevant plastic spacers.

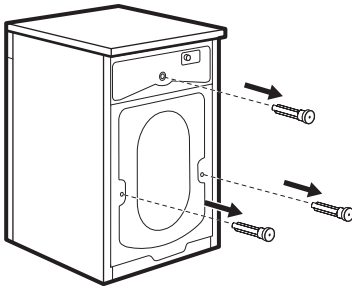

5. Open the porthole and remove the polystyrene block fitted on the door seal.

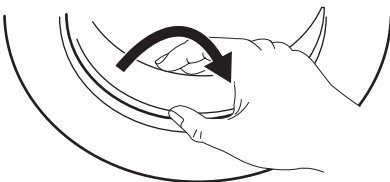

6. Fill the smaller upper hole and the two large ones with the corresponding plastic plug caps supplied in the bag containing the instruction booklet.

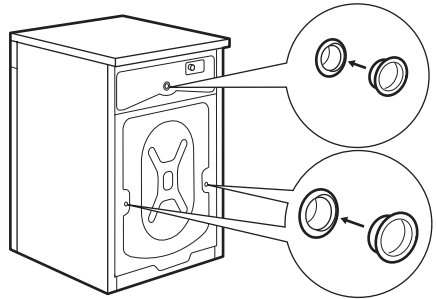

POSITIONING

Install the machine on a flat hard floor. Make sure that air circulation around the machine is not impeded by carpets, rugs etc. Check that the machine does not touch the wall or other kitchen units. Level the washing machine by raising or lowering the feet. The feet may be tight to adjust as they incorporate a self locking nut, but the machine **MUST** be level and stable. If necessary, check the setting with a spirit level. Any necessary adjustment can be made with a spanner. Accurate levelling prevents vibration, noise and displacement of the machine during operation.

! Caution! Never place cardboard, wood or similar materials under the machine to compensate for any unevenness in the floor.

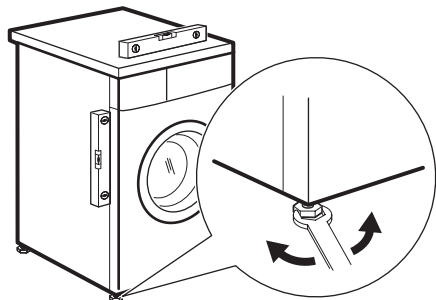

RUBBER FEET KIT (4055126249)

Available from your authorized dealer.

The rubber feet are particularly recommended on floating, slippery and wooden floors. Mount the rubber feet to prevent vibration, noises and displacement of the appliance during operation. Read carefully the instructions supplied with the kit.

WATER INLET

An inlet hose is supplied and can be found inside the machine drum. Do not use the hose from your previous machine to connect to the water supply.

Important! This appliance must be connected to a cold water supply.

1. Open the porthole and extract the inlet hose.
2. Connect the hose with the angled connection to the machine. Do not place the inlet hose downwards. Angle the hose to the left or right depending on the position of your water tap.

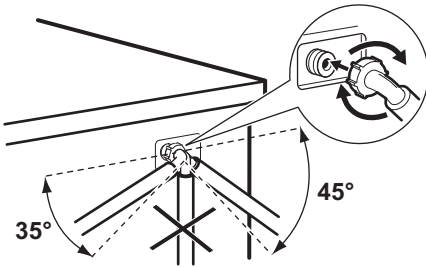

3. Set the hose correctly by loosening the ring nut. After positioning the inlet hose, be sure to tighten the ring nut again to prevent leaks.

4. Connect the hose to a tap with a 3/4" thread. Always use the hose supplied with the appliance.

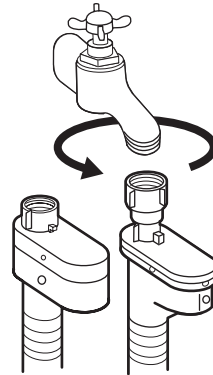

The inlet hose must not be lengthened. If it is too short and you do not wish to move the tap, you will have to purchase a new, longer hose specially designed for this type of use.

WATER-STOP DEVICE

The inlet hose is provided with a water stop device, which protects against damage caused by water leaks in the hose which could develop due to natural ageing of the hose. This fault is shown by a red sector in the window «A». Should this occur, turn the water tap off and refer to your Service Centre to replace the hose.

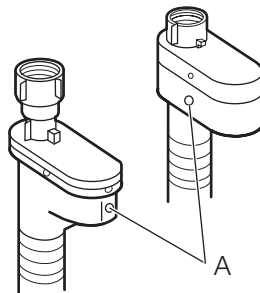

WATER DRAINAGE

The end of the drain hose can be positioned in three ways.

- **Hooked over the edge of a sink** using the plastic hose guide supplied with the machine. In this case, make sure the end cannot come unhooked when the ma-

chine is emptying. This could be done by tying it to the tap with a piece of string or attaching it to the wall.

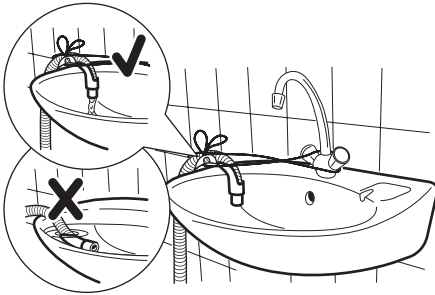

- **In a sink drain pipe branch.** This branch must be above the trap so that the bend is at least 60 cm above the ground.
- **Directly into a drain pipe** at a height of not less than 60 cm and not more than 90 cm. The end of the drain hose must always be ventilated, i.e. the inside diameter of the drain pipe must be larger than the outside diameter of the drain hose. The drain hose must not be kinked.

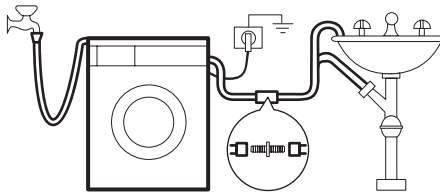

The drain hose may be extended to a maximum of 4 metres. An additional drain hose and joining piece is available from your local Service Centre.

ELECTRICAL CONNECTION

Information on the electrical connection is given on the rating plate on the inner edge of the appliance door.

Check that your domestic electrical installation can take the maximum load required, also taking into account any other appliances in use.

! **Connect the machine to an earthed socket.**

! **The manufacturer does not accept any responsibility for damage or**

injury through failure to comply with the above safety precaution.

! **The power supply cable must be easily accessible after installing the machine.**

! **Should the appliance power supply cable need to be replaced, this must be carried out by a Service Centre.**

ENVIRONMENT CONCERNS

The symbol  on the product or on its packaging indicates that this product may not be treated as household waste. Instead it should be taken to the appropriate collection point for the recycling of electrical and electronic equipment. By ensuring this product is disposed of correctly, you will help prevent potential negative

consequences for the environment and human health, which could otherwise be caused by inappropriate waste handling of this product. For more detailed information about recycling of this product, please contact your local council, your household waste disposal service or the shop where you purchased the product.

PACKAGING MATERIALS

The materials marked with the symbol  are recyclable.

>PE<=polyethylene

>PS<=polystyrene

>PP<=polypropylene

This means that they can be recycled by disposing of them properly in appropriate collection containers.

ECOLOGICAL HINTS

To save water, energy and to help protect the environment, we recommend that you follow these tips:

- Normally soiled laundry may be washed without prewashing in order to save detergent, water and time (the environment is protected too!).
- The machine works more economically if it is fully loaded.
- With adequate pre-treatment, stains and limited soiling can be removed; the laundry can then be washed at a lower temperature.
- Measure out detergent according to the water hardness, the degree of soiling and the quantity of laundry being washed.

www.electrolux.com/shop

132930370-B-472011



CE

